

PREČERPAVACIA ŠACHTA

PODORYS

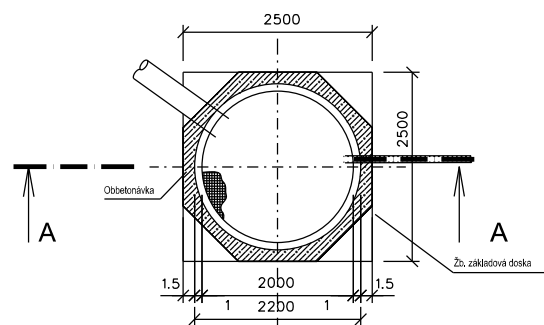

REZ A-A

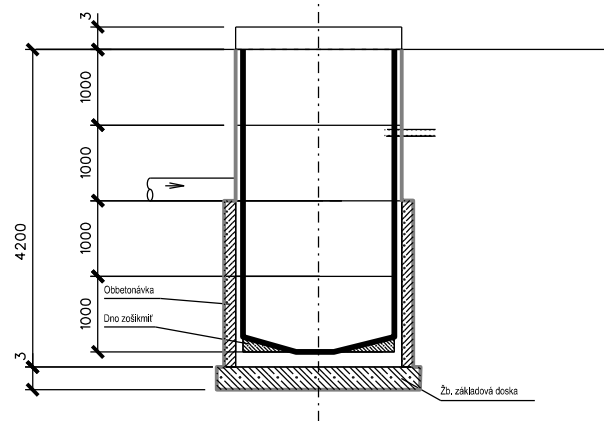

SPEVNENÁ KOMUNIKÁCIA

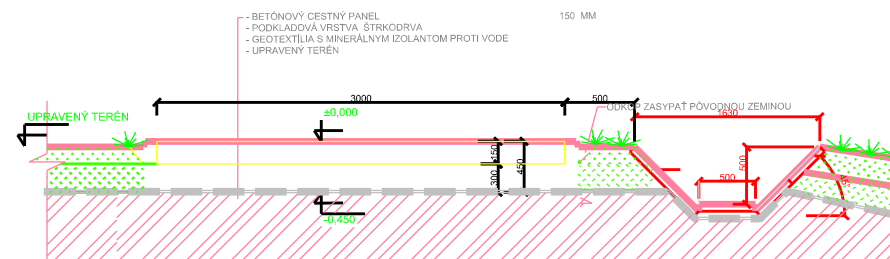

POVRCHOVÝ RIGOL

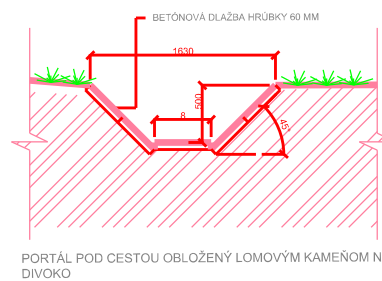

RETENČNÁ NÁDRŽ

PODORYS

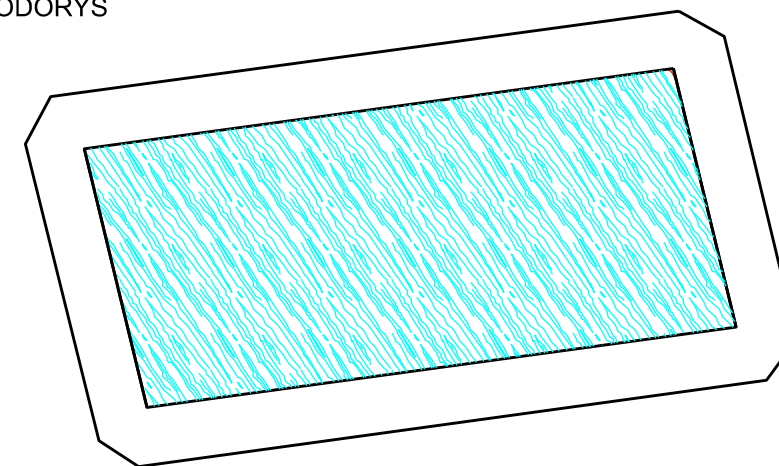

REZ HRÁDZOU

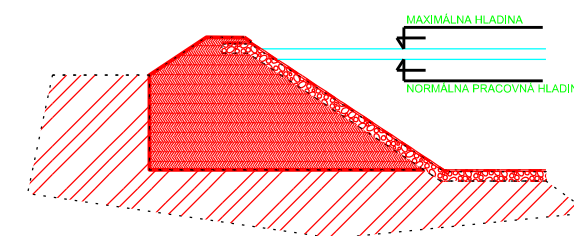

ODPLYŇOVACIA ŠACHTA

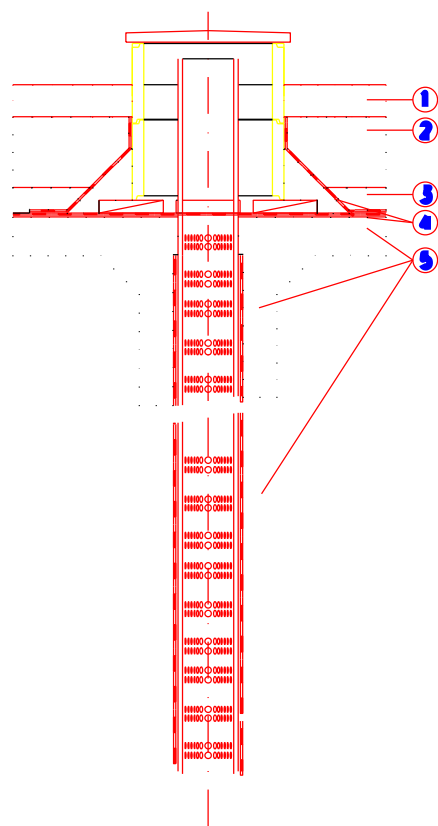

OCHRANÝ ZEMNÝ VAL

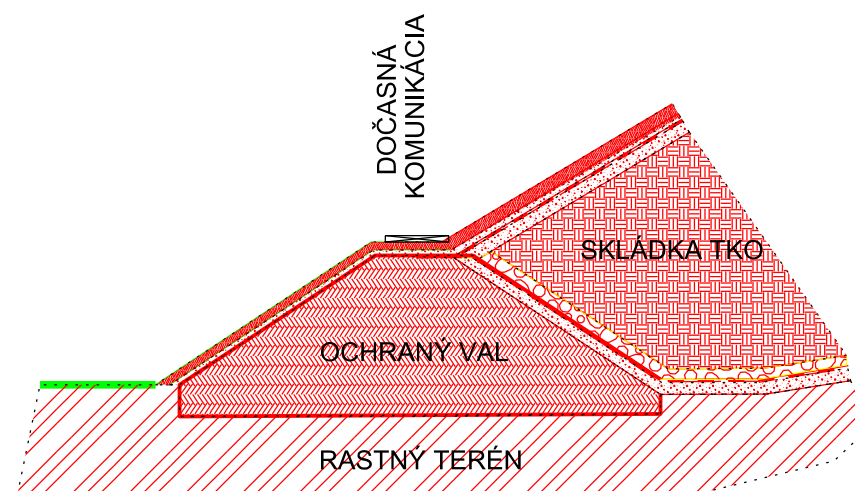

AUTOR	Jarolím Balco		
AUTORIZOVAL:	Ing. Vit Svoboda		
VYPRACOVAL	Jarolím Balco		
KRESLIL	Jarolím Balco		
OBJEDNÁVATEĽ			
STAVBA	SKLÁDKA PRE NIE NEBEZPEČNÝ ODPAD SKÁĽKA, STARÁ ĽUBOVŇA ROZŠÍRENIE KAPACITY	FORMAT	2 A4
		DÁTUM	05 / 2011
		STUPEŇ	
		MIERKA	Č VÝKRESU
OBSAH	STAVEBNÉ OBJEKTY		5